



D-BOX VIBE

— USER GUIDE —

TABLE OF CONTENTS

REGULATORY COMPLIANCE STATEMENTS	3
IMPORTANT SAFETY INSTRUCTIONS	4
D-BOX VIBE SPECIFICATIONS:	6
1. PACKAGE CONTENTS.....	7
2. UNBOXING	7
3. CHAIR ASSEMBLY	7
4. CHAIR COMPONENTS.....	8
4.1 Control Panel.....	9
4.2 D-BOX HaptiSync Processor	10
4.3 D-BOX Haptic Module	11
5. SYSTEM CONNECTION	11
6. D-BOX VIBE CONFIGURATION.....	12
6.1 D-BOX Connect Account Creation.....	12
6.2 D-BOX HaptiSync Subscription	13
6.3 D-BOX HaptiSync App Installation.....	13
6.4 HaptiSync Recognition Technology.....	14
7. TEST YOUR SYSTEM.....	14
8. CALIBRATE YOUR SYSTEM.....	15
9. PLAY.....	15
9.1 Content Synchronization using the audio sensor (Basic Setup)	15
9.2 Content Synchronization using the AUDIO IN Jack	16
9.3 Content Synchronization & D-BOX Coded Gaming Using an External Computer.....	17

REGULATORY COMPLIANCE STATEMENTS

FCC Regulatory Compliance

This device complies with Part 15 of the FCC Rules. Operation is subject to the following two conditions: (1) this device does not cause harmful interference, and (2) this device must accept any interference received, including interference that may cause undesired operation.

Note: This equipment has been tested and found to comply with the limits for a Class B digital device, pursuant to Part 15 of the FCC Rules. These limits are designed to provide reasonable protection against harmful interference in a residential installation. This equipment generates, uses and can radiate radio frequency energy and, if not installed and used in accordance with the instructions, may cause harmful interference to radio communications. However, there is no guarantee that interference will not occur in a particular installation.

If this equipment does cause harmful interference to radio or television reception, which can be determined by turning the equipment off and on, the user is encouraged to try correcting the interference by one or more of the following measures:

- Reorient or relocate the VIBE chair.
- Increase the separation between the equipment and receiver.
- Connect the equipment into an outlet on a different circuit from that to which the receiver is connected.
- Consult the dealer or an experienced radio/TV technician for help.
- Warning: any changes or modifications not expressly approved by the party responsible for compliance could void the user's authority to operate the equipment.

RF Exposure Compliance

This equipment complies with FCC radiation exposure limits set forth for an uncontrolled environment. This equipment should be installed and operated with a minimum distance of 20 cm between the radiator and your body. This transmitter must not be co-located or operating in conjunction with any other antenna or transmitter.

Supplier's Declaration of Conformity

47 CFR § 2.1077 Compliance Information

Unique Identifier Trade Name: D-BOX Technologies Inc., Model No.: H300

Responsible Party – U.S. Contact Information

D-BOX Technologies Inc.

2172 Rue de la Province, Longueuil, Quebec J4G 1R7 Canada

1-450-442-3003

FCC Compliance Statement

This device complies with Part 15 of the FCC Rules. Operation is subject to the following two conditions: (1) This device does not cause harmful interference, and (2) this device must accept any interference received, including interference that may cause undesired operation.

ISED Regulatory Compliance

This device contains licence-exempt transmitter(s)/receiver(s) that comply with Innovation, Science and Economic Development Canada's licence-exempt RSS(s). Operation is subject to the following two conditions:

1. This device may not cause interference.
2. This device must accept any interference, including interference that may cause undesired operation of the device

This equipment complies with IC RSS-102 radiation exposure limits set forth for an uncontrolled environment. This transmitter must not be co-located or operating in conjunction with any other antenna or transmitter. This equipment should be installed and operated with minimum distance 20cm between the radiator and your body.

CAN ICES-3 (B)/NMB-3(B)

IMPORTANT SAFETY INSTRUCTIONS

- Read, keep, and follow these instructions.
- Heed all warnings:



This D-BOX Haptic System may be harmful to women who are pregnant, persons with heart conditions, the elderly, or those with other pre-existing medical conditions. All such persons should consult their physicians before using this D-BOX Haptic System.



Use of this D-BOX Haptic System is not recommended for children under the age of ten years old without adult supervision. Owners and/or users of this D-BOX Haptic System should consult and comply with the user guide enclosed



Use of this D-BOX Haptic System is a risk to hands and feet. Do not put hands or feet underneath the seat or near the haptic system. This may lead to serious injury.



Unplug this device during electrical storms or when unused for long periods of time.



Use of hot liquids in the vicinity of this D-BOX Haptic System should always be avoided to prevent spillage which could cause serious injuries to the user.



Do not install near any heat sources such as radiators, heat registers, stoves, or any other appliances (including amplifiers).



Do not use this device near water.



Refer all servicing to qualified personnel. Servicing is required when the device has been damaged in any way. For example: if liquid has been spilled or objects have fallen onto it, if it has been exposed to rain or moisture, if it does not operate normally or, if it has been dropped.



- Only clean the device with a dry cloth.
- Do not block any ventilation openings. Install in accordance with the manufacturer's instructions.
- Protect all the cables (USB, network, power, etc.) from being walked on or pinched, particularly at the ends.
- Use only attachments/accessories specified by the manufacturer.

Owners and/or users of this D-BOX Haptic System are responsible for the dissemination of this information to all such persons named herein. Each owner and/or user of this D-BOX Haptic System agrees to evaluate and bear all risks associated with the use of this D-BOX Haptic System for themselves and for any subsequent users of this D-BOX Haptic System and any subsequent users of this D-BOX Haptic System shall be deemed to be using this D-BOX Haptic System under the direct supervision of such owner/user and such owner/user will be deemed to have communicated this advisory to all person described herein.

D-BOX Technologies Inc. is in no way responsible for any damages of any kind arising from the use of this D-BOX Haptic System and the owners and/or users of this D-BOX Haptic System hereby agree not to hold D-BOX Technologies Inc. responsible for any and all damages of any kind arising from the use of this D-BOX Haptic System including, but not limited to direct or indirect, punitive, incidental, special or consequential damages arising out of or in any way connected with the use of this D-BOX Haptic System.

Congratulations on purchasing your new at-home D-BOX VIBE chair!

Life is a journey, and we hope that your new VIBE chair will add more thrilling experiences to your life! At D-BOX, we believe that your body is the ultimate vehicle to make life resonate; that by tapping into its sensory potential with perfectly synchronized haptic technology we can create richer, fuller experiences and bring the ultimate experience to your home!

Your new VIBE chair is designed to be used with the D-BOX HaptiSync App and features an integrated sound sensor capable of synchronizing your favourite movies, series, music, and more experiential content using your room's ambient sound. With haptic codes available for more than 2,500 titles and the new adaptive audio mode, watching movies, series and more at home will never FEEL the same again!

Use your tablet, smartphone, or PC to quickly and easily adjust your D-BOX VIBE chair by configuring your HaptiSync App!

Do not hesitate to contact us if you have questions.

Please make sure to provide the **serial number** of your VIBE chair when contacting the D-BOX Support.

The serial number is available in your D-BOX HaptiSync app. It is also located on the shipping box as well as on the side of the back panel module:



D-BOX Support

2172 rue de la Province, Longueuil, Quebec, Canada

BY EMAIL: support@d-box.com

BY PHONE 1-800-442-3269; 931 (toll free CAN/US)
1-450-442-3003; 931 (other regions)



D-BOX VIBE SPECIFICATIONS:

TECHNICAL SPECIFICATIONS	
POWER REQUIREMENTS (Max.)	120V, 50/60 Hz, 2A 230V, 50/60 Hz, 1.1A
MAXIMUM LIFTING CAPACITY	250 lbs (122 kg)
MAX ANGULAR DISPLACEMENT FOR PITCH	+/- 5°
MAXIMUM VELOCITY	100 mm/s
MAXIMUM ACCELERATION	+/- 1 g-force
FREQUENCY RANGE	0-100 Hz
OPERATING TEMPERATURE RANGE	0°C – 40°C (41°F – 104°F)
OPERATING HYGROMETRY	10 to 85% (Free from condensing)
WEIGHT	89.3 lbs (40.5 kg)

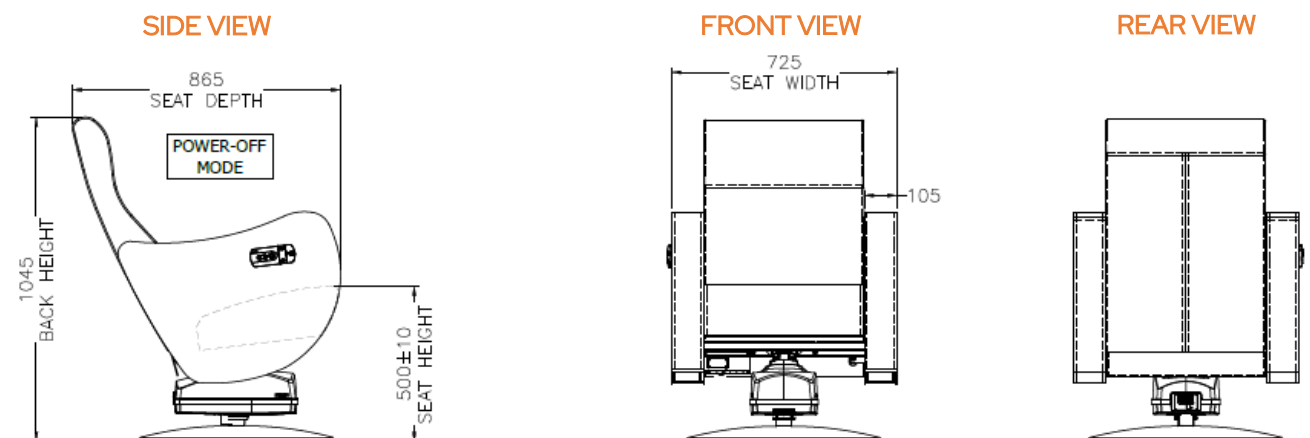

1. PACKAGE CONTENTS



> 1x D-BOX VIBE Chair (Partially assembled)



> 1x USB A to USB B Cable



> 1x IEC Male to IEC Female Power Cable



> 1x IEC Power Cable (Plug type vary depending on your country)

2. UNBOXING

- Unpack the product from the box.
- Visually inspect the product for damage.
- If any part appears to be broken, contact the D-BOX Support Team.

3. CHAIR ASSEMBLY

Your new D-BOX VIBE chair comes preassembled. Please follow the steps below to complete the assembly:

STEP 1: Install your new chair on a flat surface to ensure a proper operation:



STEP 2: Remove the two (2) screw from the bottom back of the seat using a 13mm wrench:



STEP 3: Flip manually the backrest to its upright position:



STEP 4: Secure the backrest by tighten both screws located at the rear bottom of the seat using a 13mm wrench:



4. CHAIR COMPONENTS

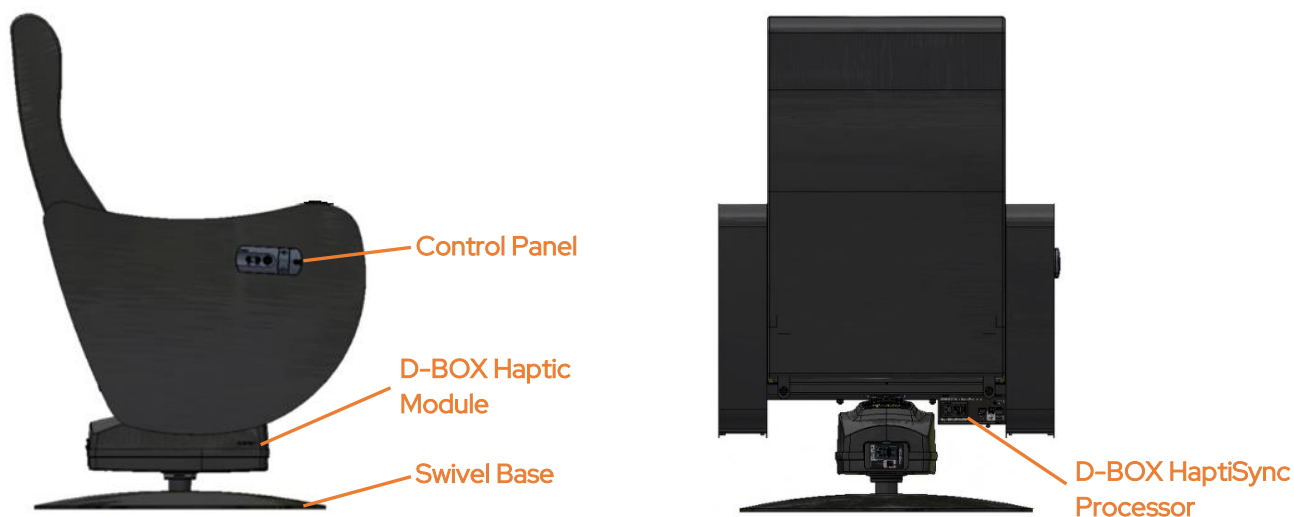

4.1 Control Panel

Your D-BOX VIBE chair is equipped with a control panel located on the outside of the right armrest:

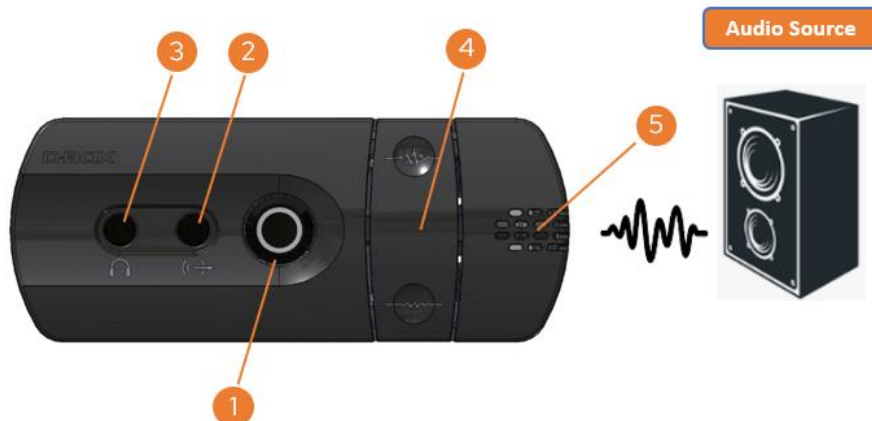

- 1 Power Operation Button**
Used to turn the power of the VIBE chair.
- 2 Audio Line In**
Used to connect a 3.5mm analog stereo audio source to sense the audio content.
Not required when using the audio sensor feature.
- 3 Audio Line Out**
Used to connect 3.5mm headphones from the Audio Input.
- 4 Intensity buttons**
Used to adjust the intensity of your haptic experience.
- 5 Audio Sensor**
Used to sense the audio content.

4.1.1 Power Operation Button

The power operation button on your D-BOX VIBE chair has different functionalities. If you press the button for:

- **1 to 3 seconds, then release:** Power on/off
- **4 to 7 seconds, then release:** Network reset (while blinking twice per second)
- **8 to 11 seconds, then release:** Factory reset (while blinking 4 times per second)
- **12+ seconds:** Nothing (cancels all operations)

4.2 D-BOX HaptiSync Processor

The D-BOX HaptiSync Processor is located at the back of the chair right beside the haptic module:

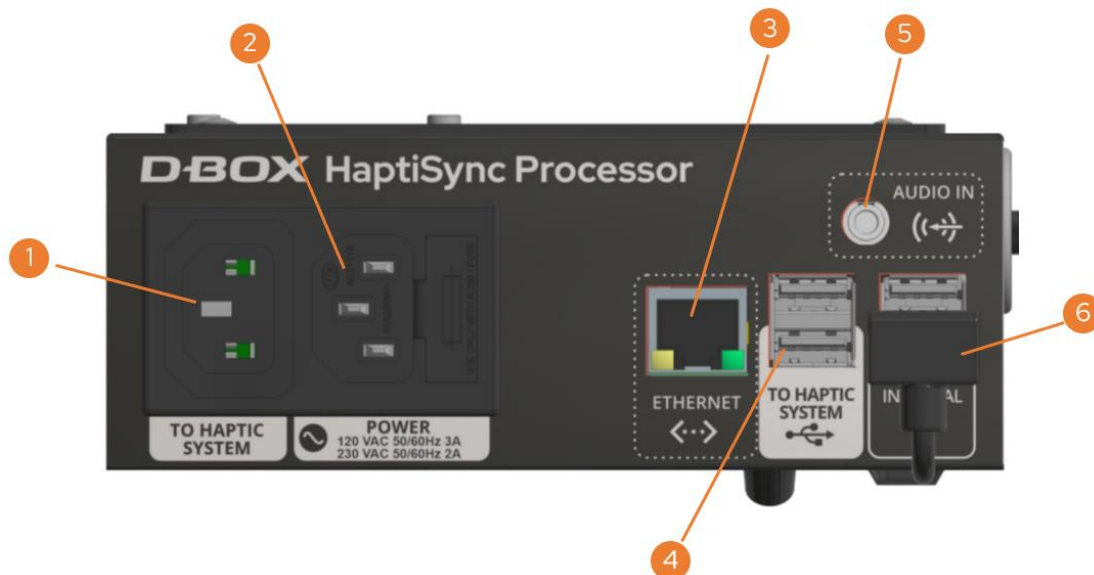

- 1 TO HAPTIC SYSTEM**
Used to connect the IEC power cable to the D-BOX Haptic Module.
- 2 POWER**
Used to connect the IEC power cable to the wall outlet.
- 3 ETHERNET**
Used to connect a LAN cable when connecting to a wired LAN network.
Not required when using Wi-Fi.
- 4 TO HAPTIC SYSTEM (USB PORT)**
Used to connect the USB cable to the D-BOX Haptic Module.
- 5 AUDIO IN**
Used to connect a 3.5mm analog stereo audio source to sense the audio content. Also available on the Control Panel.
Not required when using the integrated sound sensor feature.
- 6** Connected from factory. Do not disconnect.

4.3 D-BOX Haptic Module



- 1 POWER**
Used to connect the IEC power cable to the D-BOX HaptiSync Processor.
- 2 USB INPUT**
Used to connect the USB cable to the D-BOX HaptiSync Processor.
- 3 Power Switch**
Used to turn ON/OFF the chair.

5. SYSTEM CONNECTION

Connect the USB and power cables to the Haptic Module and HaptiSync Processor as follow:

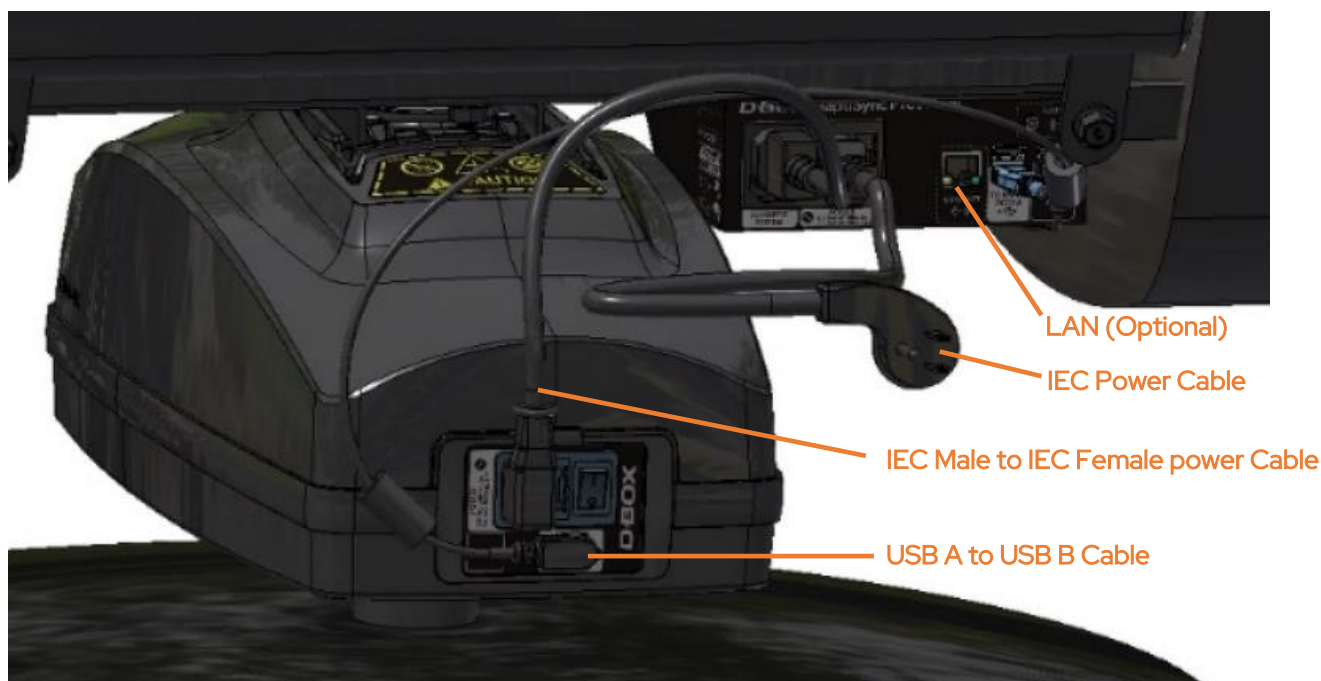

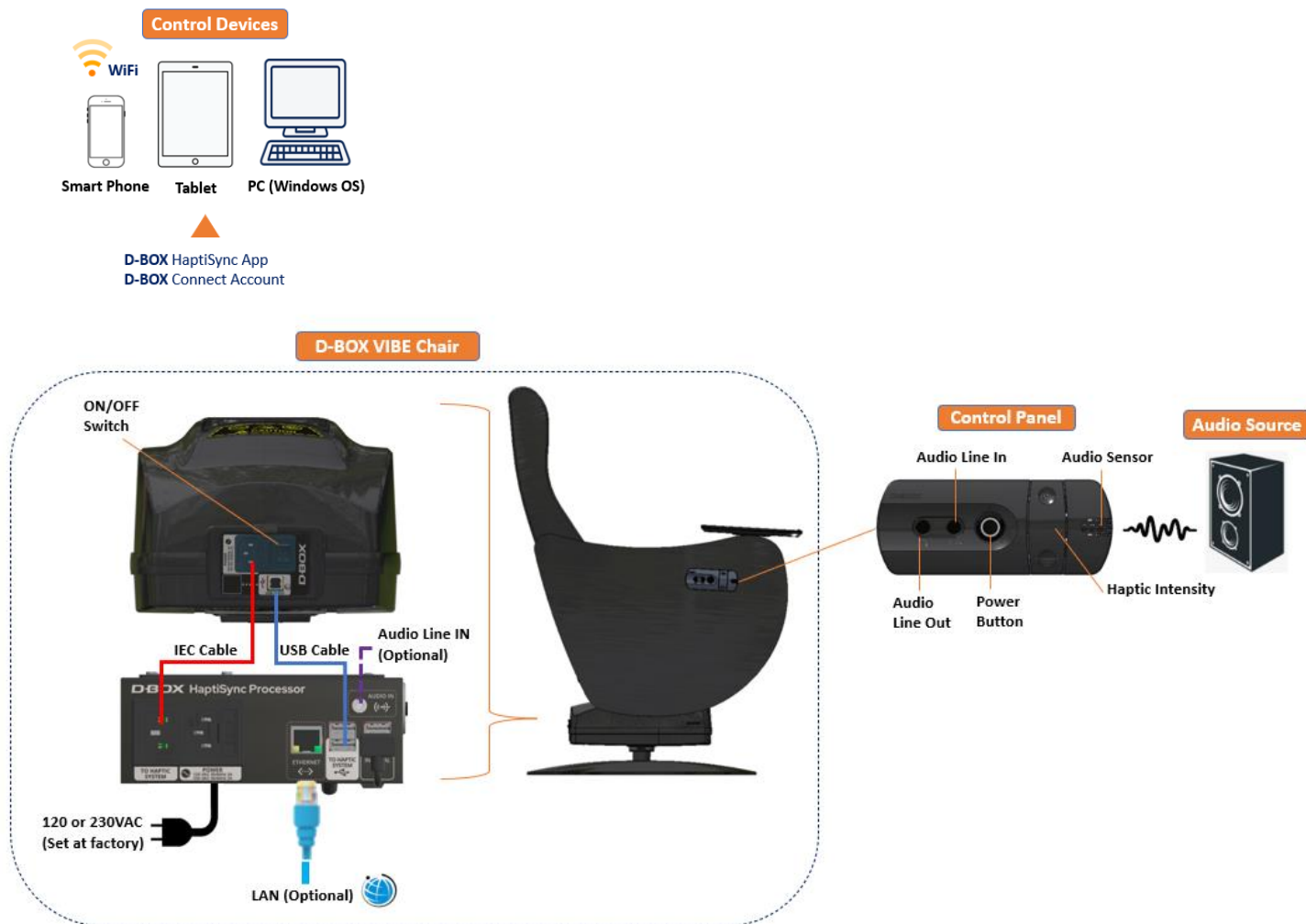

6. D-BOX VIBE CONFIGURATION

6.1 D-BOX Connect Account Creation

- Create your D-BOX account at <https://connect.d-box.com/>. This is mandatory to have access to the D-BOX Coded Video mode.
- Activate your D-BOX Connect account by clicking the link in the email you received. You will be automatically redirected to the D-BOX Connect home page.

Visit this page for detailed instructions: [D-BOX Connect Account Creation](#)

6.2 D-BOX HaptiSync Subscription

The HaptiSync subscription give you access to haptic codes for over 2500 movies! To do so, click **Subscriptions** and then **ADD SUBSCRIPTION**.

If you have a promo code, you will enter it when completing your subscription payment. Visit this page for detailed instructions: [I have a promo code. How do I use it in D-BOX Connect?](#)

6.3 D-BOX HaptiSync App Installation

The D-BOX HaptiSync App is an application that is compatible with iOS, Android and Windows devices. This app allows you to manage and customize your D-BOX VIBE chair.

- Download the D-BOX HaptiSync App from your mobile device's app store or by using one of the following download links:
 - [Apple App Store](#)
 - [Google Play Store](#)
 - [Windows download link](#) (Included in the D-BOX Motion Core)

- Connect the Haptic Processor to your network:
 - To use a wireless Wi-Fi network:
 - a) Open the HaptiSync App.
 - b) Press the "Add" button to add your D-BOX VIBE chair.
 - c) Follow the on-screen instructions to complete your network configuration (you must know your Wi-Fi password).

 - To use a wired Ethernet network:
 - a) Connect a network cable to the ETHERNET port on your D-BOX VIBE chair.
 - b) Open the HaptiSync App.
 - c) The Haptic Processor will automatically be detected.

- Activate your VIBE chair (Haptic Processor)
 - a) Make sure you have created your D-BOX Connect account and have a valid HaptiSync Subscription.
 - b) Open your Haptic Processor in the HaptiSync App.
 - c) Follow the on-screen instructions to complete activation. You will need to enter your D-BOX Connect account email and password in the app.

NOTE: It may take up to 1 hour for the HaptiSync Processor to become operational after updating the haptic codes database upon successful activation.

6.4 HaptiSync Recognition Technology

D-BOX HaptiSync Technology is the core of your VIBE chair. This complex technology enables recognition and synchronization with your on-screen content. This recognition technology matches the audio to a specific D-BOX haptic code. Since the library contains thousands of haptic codes, some titles may take longer to be recognized. To maximize your system's performance, please take the following steps:

- Your Haptic Processor should recognize any D-BOX compatible content within 30 seconds when first played from the beginning of its timeline (the first 15 minutes).
- Recently added D-BOX titles (250 latest) should be recognized when first played from anywhere in their timeline.
- For example, if you want to watch the final scene from an old movie: first play the title from the beginning, wait for the haptic processor to recognize the content, and then skip to the final scene.
- Your Haptic Processor will remember the last 10 titles that have been recognized and/or included in the last library update. When a title is stored in the Haptic Processor memory, it can recognize it faster (within 10s).
- Please note that non-original versions (such as foreign languages) may take significantly longer for the Haptic Processor to recognize.
- You can adjust the audio recognition tolerance parameters in the HaptiSync App. Audio recognition tolerance can be set between 0 and 100 seconds. If a recognition failure occurs during the specified delay (foreign languages, ambient noise, etc.), the synchronization will be maintained, and the haptic will not be interrupted. When pausing or stopping playback, the haptic will continue for the duration you selected.
 - Use a higher tolerance value (like 30s) to continue the haptic experience for portions of unrecognized audio (foreign languages, ambient noise, talking).
 - Use a lower tolerance value (like 5s) to stop haptic experiences faster when pausing or stopping playback.

7. TEST YOUR SYSTEM

- a) Make sure that all components of your HaptiSync System are powered on.
- b) Play the "[HaptiSync Test](#)" video from the "[D-BOX Haptic Experiences](#)" YouTube channel. This can be done on your mobile device by aiming the speaker toward the audio sensor located outside the right armrest.
- c) Turn up the playback sound so that the Haptic Processor can detect it. Within 30 seconds, your system should move and follow the test video. Make sure your system is moving along with the onscreen instructions.

NOTE: The high-performance haptic actuator on your D-BOX VIBE chair is carefully designed to provide immersive vibrations while minimizing noise. The actual noise levels produced are different for every location. If you experience significant noise, you can reduce the vibration intensity by using the intensity slider in the HaptiSync App.

8. CALIBRATE YOUR SYSTEM

External factors may influence synchronization delays (Distance from your screen, sound transmission, etc.). We suggest calibrating your haptic system using our calibration video that can be found on our YouTube channel [here](#). Based on this calibration test, set a motion delay between -200 to 200 milliseconds to compensate for the delay.

9. PLAY

It is now the time to enjoy your new D-BOX VIBE chair with your favorite immersive content!

- a) D-BOX has a comprehensive library of haptic codes for you to discover (or re-discover) with immersive haptic effects.
- b) The complete list of compatible titles can be found on your HaptiSync App and in the D-BOX Catalogue [here](#).
- c) To enjoy the ultimate viewing experience, start playing a D-BOX compatible title from your favourite source (disc, streaming, video-on-demand, etc.) and make sure that the sound level is comfortable.
- d) Using its integrated audio sensor (microphone), your Haptic Processor will automatically recognize any compatible title in less than 1 minute (**when played from the beginning**) and then start playing the corresponding haptic code in for your VIBE chair.
- e) After a title is recognized, you can pause, rewind, or skip ahead, and the immersive experience will resume within a few seconds.

9.1 Content Synchronization using the audio sensor (Basic Setup)

This option uses the integrated audio sensor located on the right armrest. It will synchronize your favourite movies, series, music, and more experiential content using your room's ambient sound.

NOTE: Make sure that you select the Microphone Audio Source in the HaptiSync App.

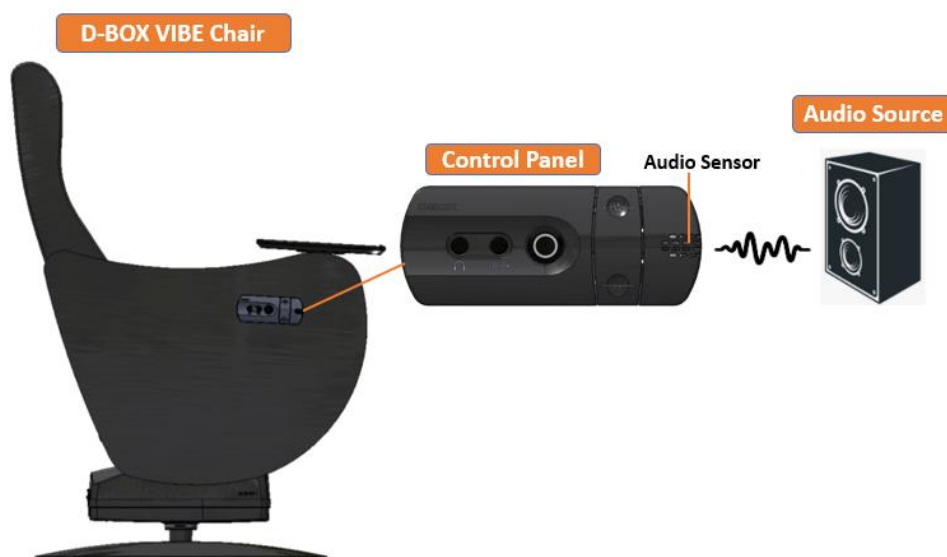

9.2 Content Synchronization using the AUDIO IN Jack

This option allows you to connect an analogue stereo source to the AUDIO IN jack from the control panel or the Haptic Processor.

This option is suitable for the following situations:

- If you want to watch a movie from your tablet, smartphone, or laptop with wired headphones.
- If you keep getting synchronization errors when using the integrated audio sensor because the sound level is too low.

NOTE: Make sure that you select the Audio Line-in Audio Source in the HaptiSync App.



*This configuration requires a stereo audio splitter (not included).

**A Lightning to Audio Jack Converter may be required for Apple devices.

9.3 Content Synchronization & D-BOX Coded Gaming Using an External Computer

This option allows you to play D-BOX coded games or use the Adaptive Gaming Mode. This setup requires to unplug the USB cable from the haptic module and connect a new USB cable from the Haptic Module to your PC:



This configuration requires to download and install the D-BOX Motion Core package on your PC [here](#).

D-BOX Motion Core: The D-BOX Motion Core Includes the system’s driver in addition to a complete software suite including the following software and utilities:

- D-BOX Control Panel
- D-BOX Game Center
- D-BOX Adaptive Gaming Configurator
- D-BOX HaptiSync App
- D-BOX System Monitor
- D-BOX Stimuli Presenter

9.3.1 D-BOX Control Panel

The D-BOX Control Panel allows you to configure system parameters such as the global intensity level, Motion /Vibration Balance, and latency. There is also a test button to verify that your system is working properly.

Default Mode:

Park: Haptic actuators will go to its lower position when there are no haptic activities (minimum electrical consumption).

Hold Center: Haptic actuators will stay in the middle position when there are no haptic activities.

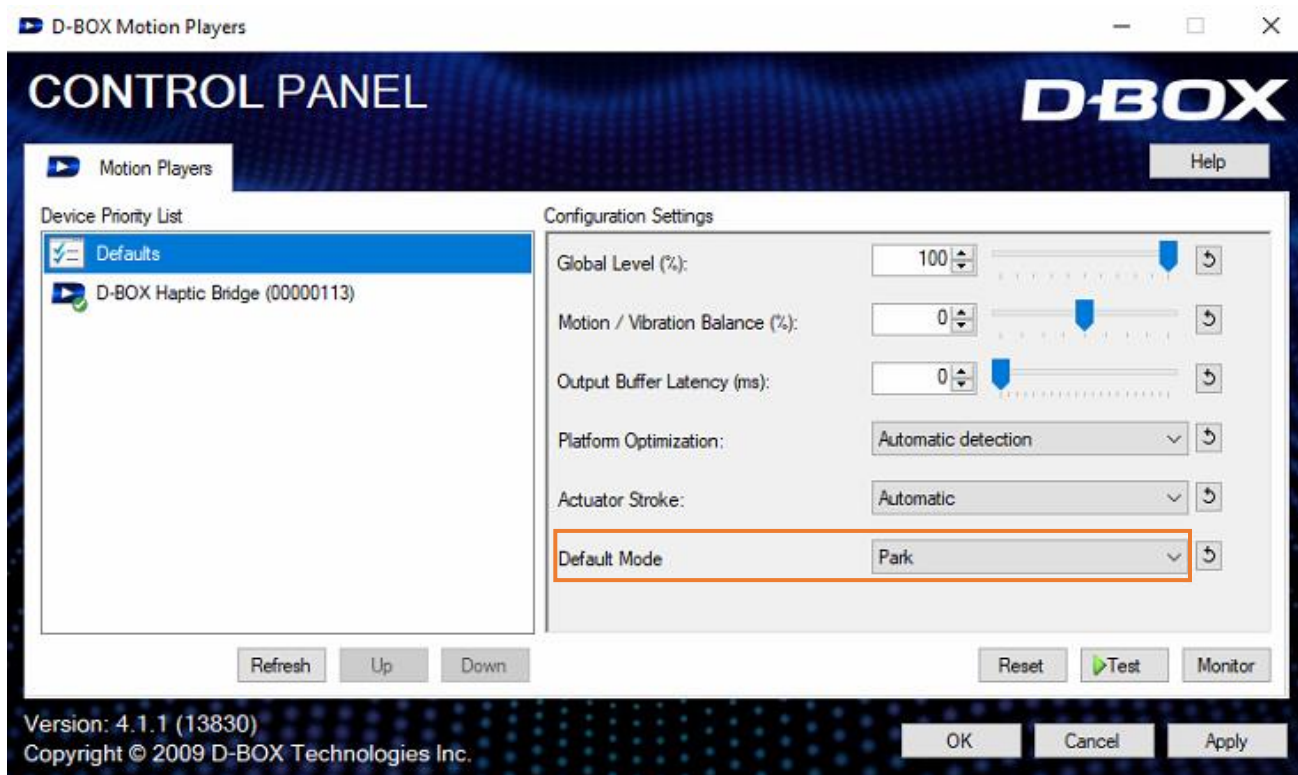

9.3.2 D-BOX Game Center

The D-BOX Game Center is an application to install the D-BOX compatible games haptic codes as well as manage and edit games profile.

NOTE: A D-BOX Connect account is required to install and receive software & haptic code updates.

Select your haptic experience from the dropdown menu:

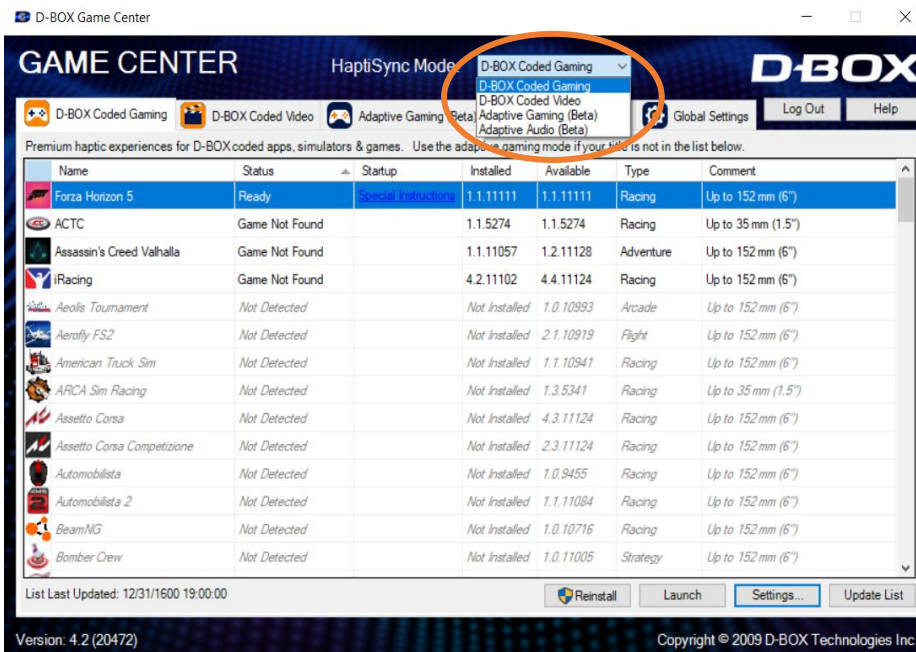

- D-BOX Coded Gaming:** Premium haptic experiences for D-BOX coded apps, simulators & games. Use the adaptive gaming mode if your title is not in the list.
- D-BOX Coded Video:** Premium haptic experiences for D-BOX coded movies, TV shows, using audio synchronization. Visit this page for detailed instructions:
<https://support.d-box.com/en/knowledge/d-box-coded-video-with-game-center>
- Adaptive Gaming:** Haptic experiences using real-time events from game controller or keyboard. Visit this page for detailed instructions on how to use this feature:
<https://support.d-box.com/en/knowledge/adaptive-gaming>
- Adaptive Audio:** Automated haptic experiences for any movie, music, TV show and games using audio processing:
<https://support.d-box.com/en/knowledge/adaptive-audio>

9.3.3 D-BOX Adaptive Gaming Configurator

This application allows you to build, modify and activate your Adaptive Gaming profiles. You can also share your favorite profiles with other D-BOX users!

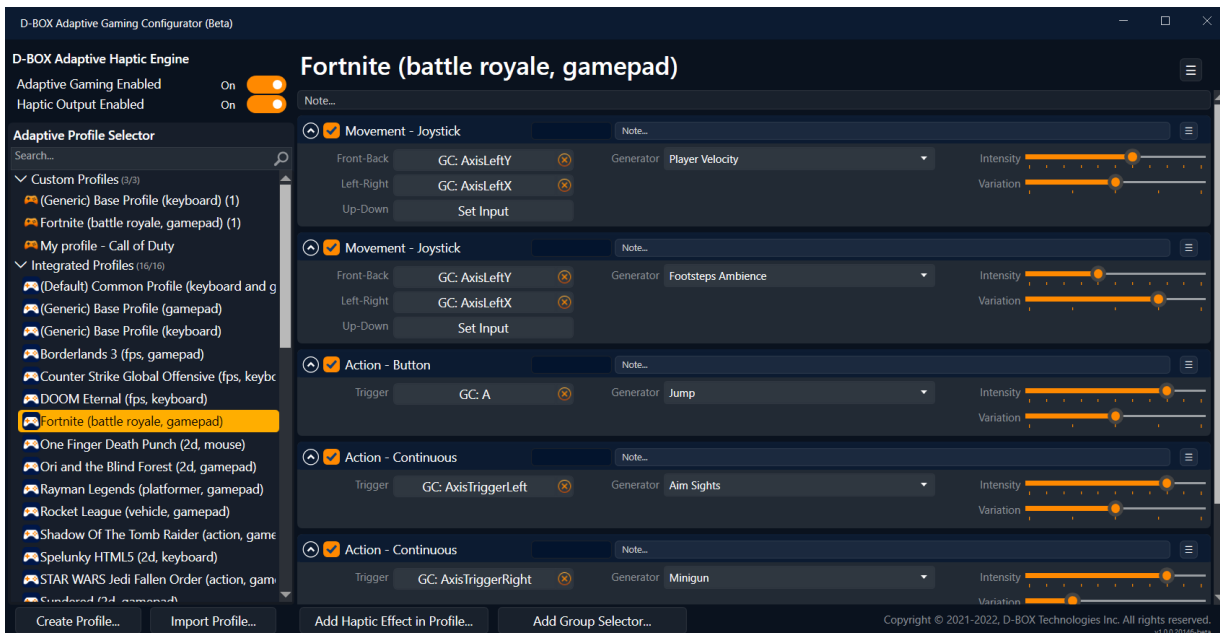

9.3.4 D-BOX HaptiSync App

This application allows you to setup and control your D-BOX Coded Video experience using audio synchronization:

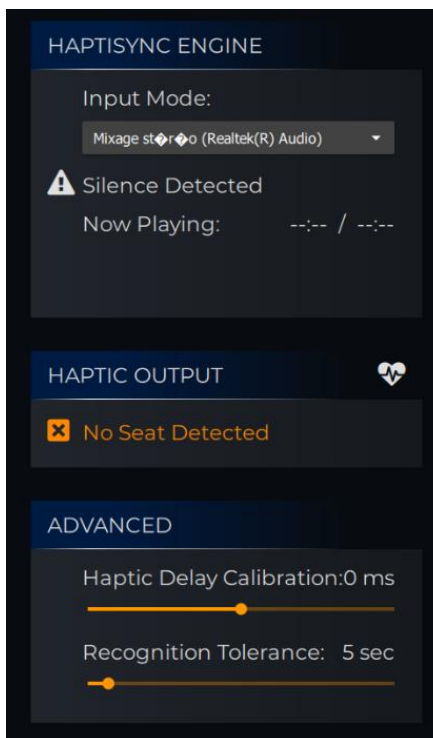
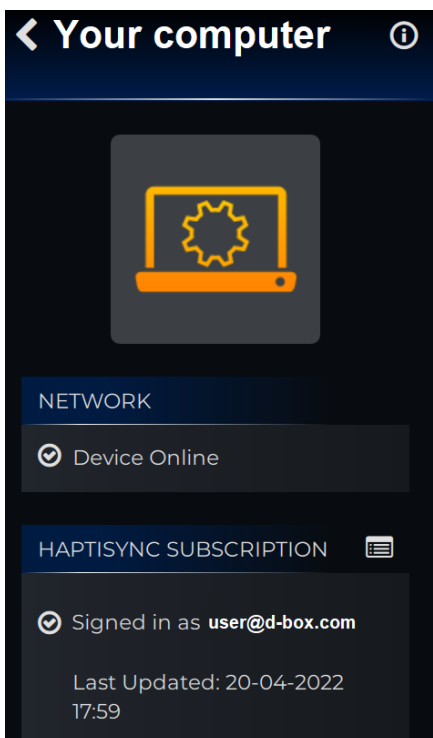

9.3.5 D-BOX System Monitor

This application displays live health and operational data on your VIBE chair. This is useful to troubleshoot your system:

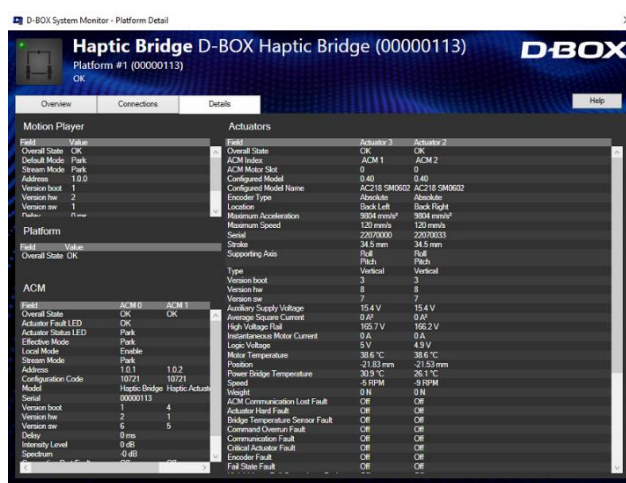
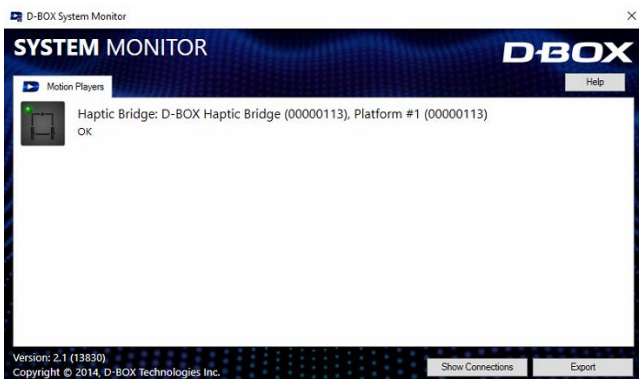

9.3.6 D-BOX Stimuli Presenter

The D-BOX Stimuli Presenter is a keyboard-controlled application to send basic signals to the haptic system, helpful for tests and demos:

